

Order at 訂貨熱線 :

香港批發/分銷 T (852) 2781 2855

澳門批發/分銷 T (853) 2822 2751

工程/商業項目 T (852) 2691 9166

E enquiry@supermoon.hk

www.supermoon.hk

# HDB6s 18mm Miniature Circuit Breaker

Standard: IEC 60898-1

Trip Curve: B, C and D curves

Breaking Capacity: 4500/6000A



## Function

HDB6s miniature circuit breakers combine the following functions:

- Protection of circuits against overload currents
- Protection of circuits against short-circuit currents
- Control
- Isolation

## Order Information

Name	Breaking Capacity	Pole	Type	Rated current
HDB6s	L: 4.5kA	1: 1P	B: B Curve	1: 1A
	N: 6kA	2: 2P	C: C Curve	2: 2A
		3: 3P	D: D Curve	...
		4: 4P		63: 63A

Type	Breaking Capacity (kA)	Rating (A)	Width	Reference		
				B curve	C curve	D curve
<b>1P</b> 	4.5/6	1	2	HDB6sN1B1	HDB6sN1C1	HDB6sL1D1
		2	2	HDB6sN1B2	HDB6sN1C2	HDB6sL1D2
		3	2	HDB6sN1B3	HDB6sN1C3	HDB6sL1D3
		4	2	HDB6sN1B4	HDB6sN1C4	HDB6sL1D4
		5	2	HDB6sN1B5	HDB6sN1C5	HDB6sL1D5
		6	2	HDB6sN1B6	HDB6sN1C6	HDB6sL1D6
		8	2	HDB6sN1B8	HDB6sN1C8	HDB6sL1D8
		10	2	HDB6sN1B10	HDB6sN1C10	HDB6sL1D10
		13	2	HDB6sN1B13	HDB6sN1C13	HDB6sL1D13
		16	2	HDB6sN1B16	HDB6sN1C16	HDB6sL1D16
		20	2	HDB6sN1B20	HDB6sN1C20	HDB6sL1D20
		25	2	HDB6sN1B25	HDB6sN1C25	HDB6sL1D25
		32	2	HDB6sN1B32	HDB6sN1C32	HDB6sL1D32
		40	2	HDB6sN1B40	HDB6sN1C40	HDB6sL1D40
		50	2	HDB6sL1B50	HDB6sL1C50	HDB6sL1D50
		63	2	HDB6sL1B63	HDB6sL1C63	HDB6sL1D63



<b>2P</b> 	4.5/6	1	4	HDB6sN2B1	HDB6sN2C1	HDB6sL2D1
		2	4	HDB6sN2B2	HDB6sN2C2	HDB6sL2D2
		3	4	HDB6sN2B3	HDB6sN2C3	HDB6sL2D3
		4	4	HDB6sN2B4	HDB6sN2C4	HDB6sL2D4
		5	4	HDB6sN2B5	HDB6sN2C5	HDB6sL2D5
		6	4	HDB6sN2B6	HDB6sN2C6	HDB6sL2D6
		8	4	HDB6sN2B8	HDB6sN2C8	HDB6sL2D8
		10	4	HDB6sN2B10	HDB6sN2C10	HDB6sL2D10
		13	4	HDB6sN2B13	HDB6sN2C13	HDB6sL2D13
		16	4	HDB6sN2B16	HDB6sN2C16	HDB6sL2D16
		20	4	HDB6sN2B20	HDB6sN2C20	HDB6sL2D20
		25	4	HDB6sN2B25	HDB6sN2C25	HDB6sL2D25
		32	4	HDB6sN2B32	HDB6sN2C32	HDB6sL2D32
		40	4	HDB6sN2B40	HDB6sN2C40	HDB6sL2D40
		50	4	HDB6sL2B50	HDB6sL2C50	HDB6sL2D50
		63	4	HDB6sL2B63	HDB6sL2C63	HDB6sL2D63



Note: Width refers to multiple of 9 mm.

# HDB6s 18mm Miniature Circuit Breaker

Standard: IEC 60898-1  
 Trip Curve: B, C and D curves  
 Breaking Capacity: 4500/6000A



## Order Information



Type	Breaking Capacity (kA)	Rating (A)	Width	Reference		
				B curve	C curve	D curve
3P 	4.5/6	1	6	HDB6sN3B1	HDB6sN3C1	HDB6sL3D1
		2	6	HDB6sN3B2	HDB6sN3C2	HDB6sL3D2
		3	6	HDB6sN3B3	HDB6sN3C3	HDB6sL3D3
		4	6	HDB6sN3B4	HDB6sN3C4	HDB6sL3D4
		5	6	HDB6sN3B5	HDB6sN3C5	HDB6sL3D5
		6	6	HDB6sN3B6	HDB6sN3C6	HDB6sL3D6
		8	6	HDB6sN3B8	HDB6sN3C8	HDB6sL3D8
		10	6	HDB6sN3B10	HDB6sN3C10	HDB6sL3D10
		13	6	HDB6sN3B13	HDB6sN3C13	HDB6sL3D13
		16	6	HDB6sN3B16	HDB6sN3C16	HDB6sL3D16
		20	6	HDB6sN3B20	HDB6sN3C20	HDB6sL3D20
		25	6	HDB6sN3B25	HDB6sN3C25	HDB6sL3D25
		32	6	HDB6sN3B32	HDB6sN3C32	HDB6sL3D32
		40	6	HDB6sN3B40	HDB6sN3C40	HDB6sL3D40
		50	6	HDB6sL3B50	HDB6sL3C50	HDB6sL3D50
		63	6	HDB6sL3B63	HDB6sL3C63	HDB6sL3D63



4P 	4.5/6	1	8	HDB6sN4B1	HDB6sN4C1	HDB6sL4D1
		2	8	HDB6sN4B2	HDB6sN4C2	HDB6sL4D2
		3	8	HDB6sN4B3	HDB6sN4C3	HDB6sL4D3
		4	8	HDB6sN4B4	HDB6sN4C4	HDB6sL4D4
		5	8	HDB6sN4B5	HDB6sN4C5	HDB6sL4D5
		6	8	HDB6sN4B6	HDB6sN4C6	HDB6sL4D6
		8	8	HDB6sN4B8	HDB6sN4C8	HDB6sL4D8
		10	8	HDB6sN4B10	HDB6sN4C10	HDB6sL4D10
		13	8	HDB6sN4B13	HDB6sN4C13	HDB6sL4D13
		16	8	HDB6sN4B16	HDB6sN4C16	HDB6sL4D16
		20	8	HDB6sN4B20	HDB6sN4C20	HDB6sL4D20
		25	8	HDB6sN4B25	HDB6sN4C25	HDB6sL4D25
		32	8	HDB6sN4B32	HDB6sN4C32	HDB6sL4D32
		40	8	HDB6sN4B40	HDB6sN4C40	HDB6sL4D40
		50	8	HDB6sL4B50	HDB6sL4C50	HDB6sL4D50
		63	8	HDB6sL4B63	HDB6sL4C63	HDB6sL4D63

Note: Width refers to multiple of 9 mm.

Final Distribution

# HDB6s 18mm Miniature Circuit Breaker

Standard: IEC 60898-1

Trip Curve: B, C and D curves

Breaking Capacity: 4500/6000A



## Technical Data

MCB	HDB6s 18mm Circuit Breaker					
Electrical Features	Standard	IEC 60898-1				
	Certification	KEMA CB CE				
	Poles	1-4P				
	Rated Current In	1, 2, 3, 4, 5, 6, 8, 10, 13, 16, 20, 25, 32, 40, 50, 63A				
	Rated Voltage Ue	230/400V AC				
	Insulation Voltage Ui	500V				
	Breaking Capacity Icn					
		Rate current(A)	Breaking capacity Icn(kA)	Type	Poles	Voltage (V)
		1-40	6	B,C	1P 2P, 3P, 4P	230/400 400
		50,63	4.5	B,C	1P 2P, 3P, 4P	230/400 400
	1-63	4.5	D	1P 2P, 3P, 4P	230/400 400	
Tripping Curve ( see following tripping curve pictures)						
B curve;the magnetic release operates between 3 and 5 In						
C curve;the magnetic release operates between 5 and 10 In						
D curve;the magnetic release operates between 10 and 14 In						
Mechanical Features	Electrical Durability	4000 times				
	Mechanical Durability	10000 times				
	Protection Degree	2				
	Tropicalization	treatment 2				
	Ambient Temperature	-5°C ~ +40°C				
Connection	Up to 25mm <sup>2</sup> cables					
Installation	Rate Current(A)	Screw	Rated Torque (Nm)	Limiting Torque (Nm)		
	1-63	M5	2.5	4.5		
Mounting	35mm Din-rail					
Accessories	Contact Accessory	OF				
	Fault-indicating Accessory	SD				
	Shunt-trip Release	MX+OF				

Final Distribution

# HDB6s 18mm Miniature Circuit Breaker

Standard: IEC 60898-1

Trip Curve: B, C and D curves

Breaking Capacity: 4500/6000A



## Tripping Curves

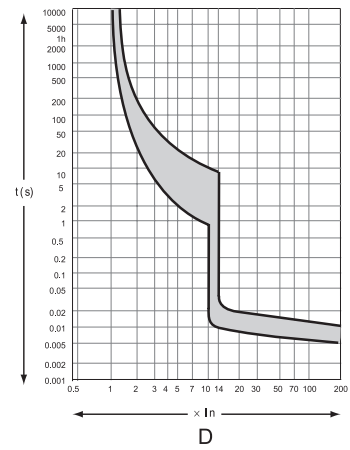
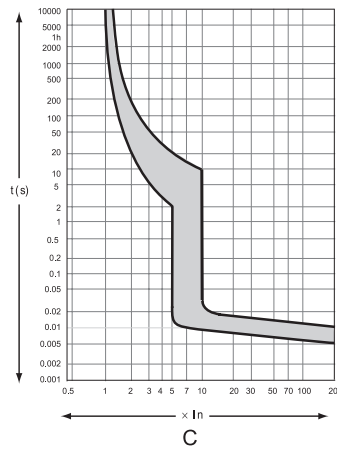
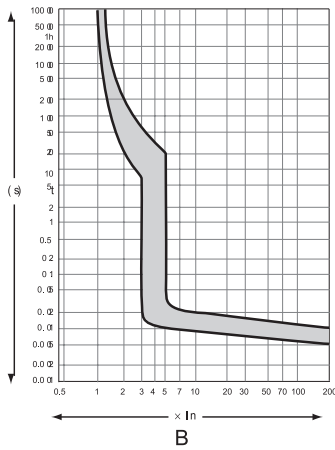

## Overall Dimensions

Unit: mm

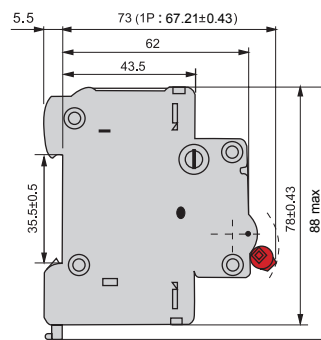
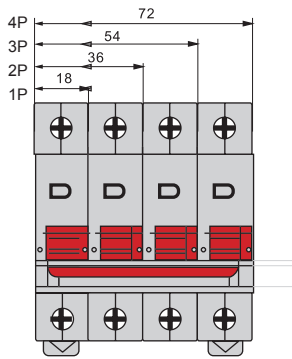

## Accessories

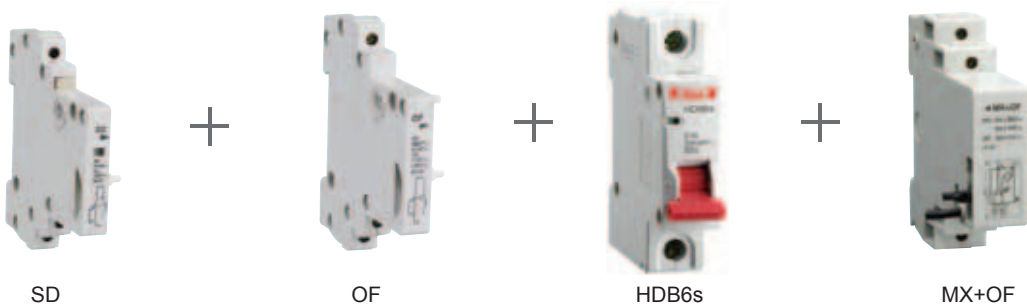

Final Distribution